



Citrix XenDesktop/XenApp 7.6

Technical Update

Roger Bösch

Citrix Systems International GmbH





XenApp & XenDesktop 7.6

Flexcast Management Architecture

XenApp



XenDesktop

Windows app virtualization

Windows app and desktop virtualization

Mobilize Windows apps for maximum security, control and performance

Deliver virtual Windows desktops with the best cost, performance and security for every business need

Build-on the FlexCast Management Architecture (FMA)



Independent Management Architecture
XenApp 6.5 and before



Flexcast Management Architecture
XenApp 7.x & XenDesktop 5.x

Different Infrastructures (old way)

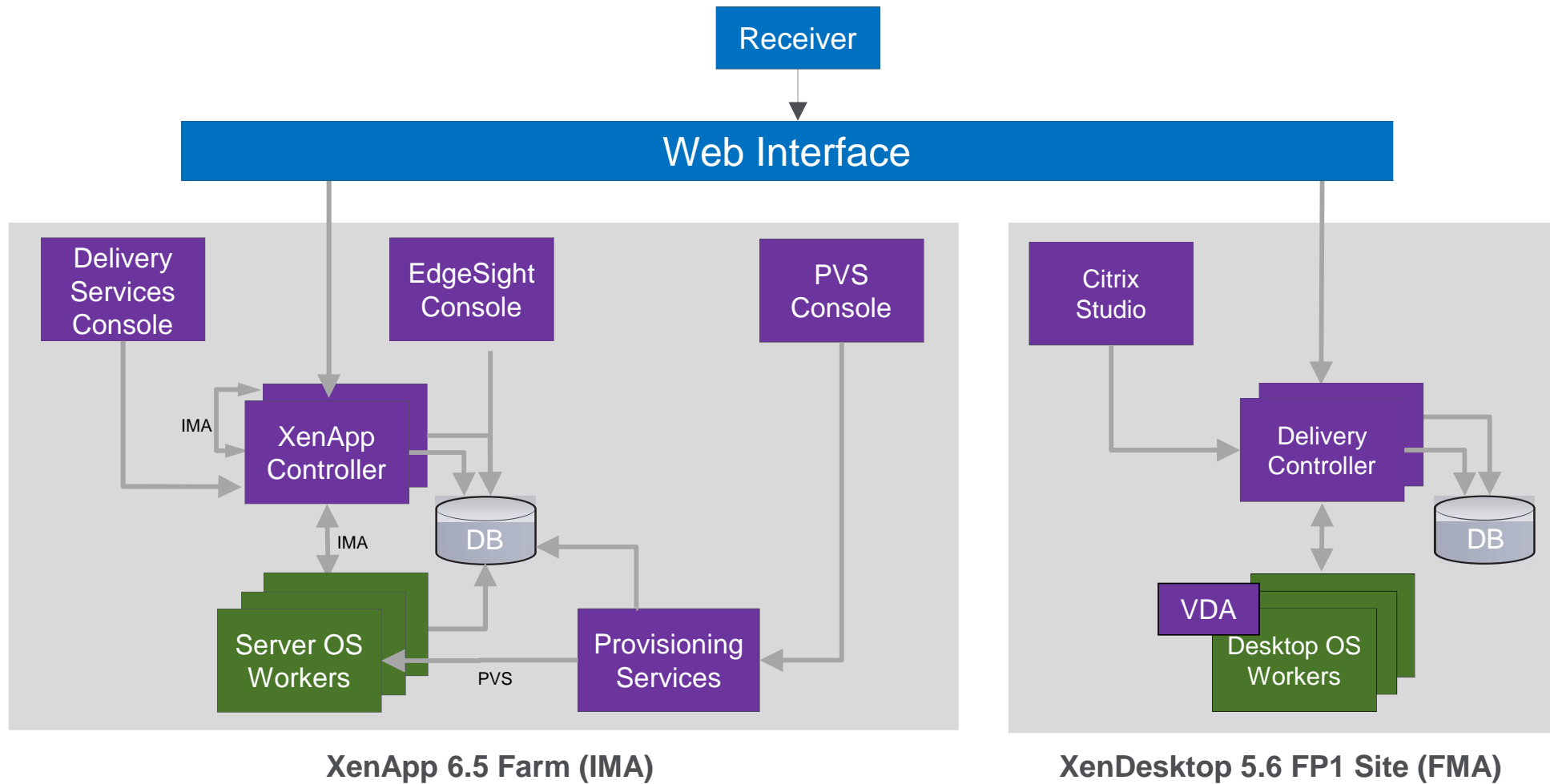

Integrated FMA

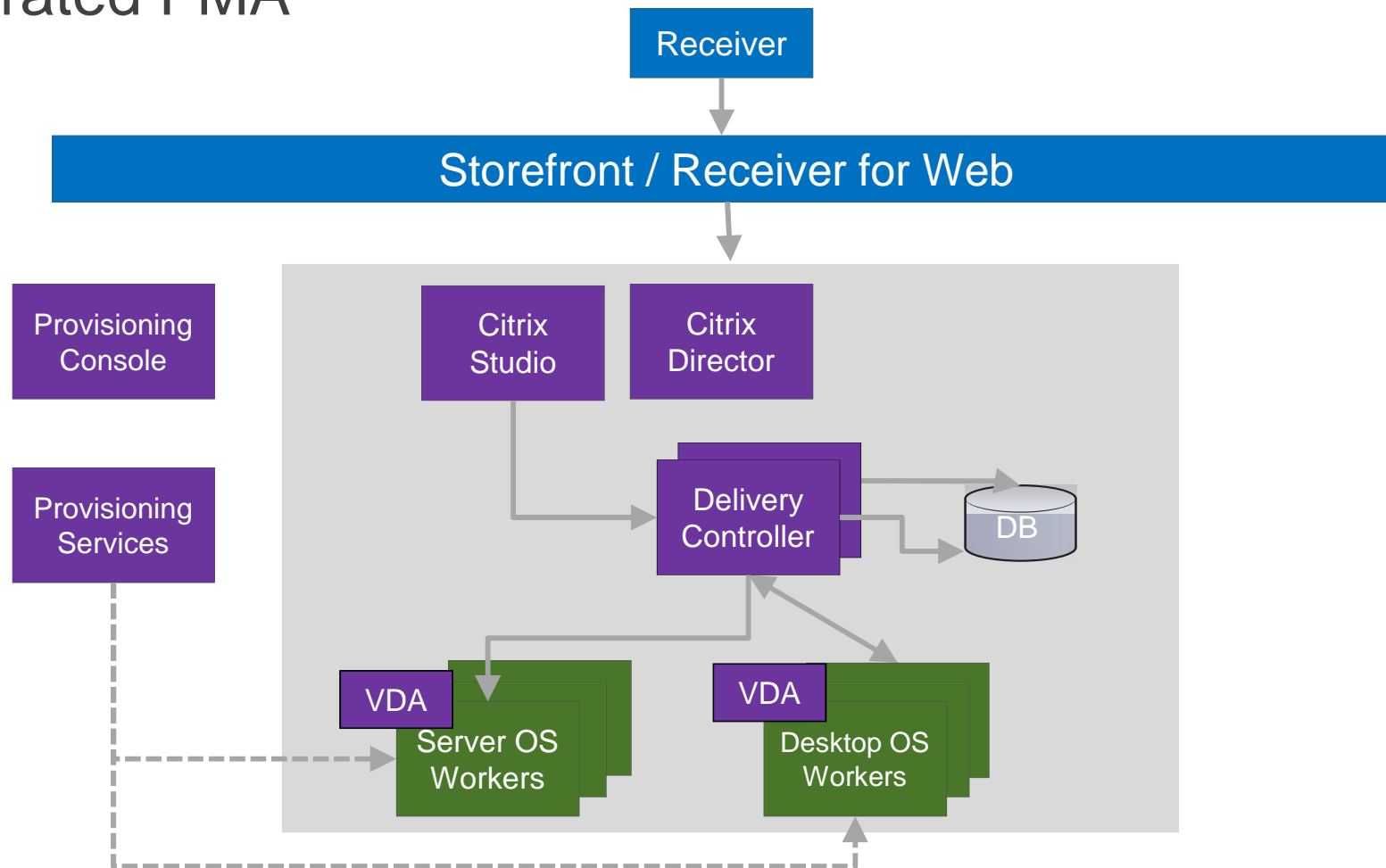



**Configuration/Change Management
(Studio)**



**Monitoring/Troubleshooting
(Director)**

**XenDesktop 7.x Infrastructure
Server 2008R2 / Server 2012 / Server 2012R2**

Win XP Catalog	Win 7 Catalog	Win2K8 R2 RDS Catalog	Win2K8 R2 RDS Catalog	Win2K8 R2 RDS Catalog	Server 2012 RDS Catalog	Win 8 Catalog	Win 8 Catalog	Server 2012 RDS Catalog	Server 2012 RDS Catalog
Personal Desktops	Hosted Shared	Hosted Shared Apps			Personal Win8 Desktops		Hosted Shared		

Subscribers

XenApp Editions

Packaged and priced for tactical adoption

XenApp 7.6

With Concurrent Licensing Only

Advanced Edition

Solid foundation for secure, on-demand application delivery to users anywhere with maximum performance

Enterprise Edition

Proven enterprise class, on-demand, high-performance hosted shared app and desktop virtualization solution with HDX™ technology that is optimized for managing larger environments

Platinum Edition

Most robust and secure solution to deliver applications as an on-demand service to any user with powerful tools for greater scalability, control and visibility of the most complex environments

XenDesktop Editions

Packaged and priced for broad adoption for all users

XenDesktop 7.6

With User/Device or Concurrent
Licensing

VDI
Edition

Scalable VDI-only
implementations
with HDX™ technology

Enterprise
Edition

Enterprise-class desktop
virtualization with FlexCast™
delivery technology

Platinum
Edition

Comprehensive desktop
virtualization solution with
advanced networking,
management and security



Superior User Experience

Superior User Experience

Extending HDX Technology

What's New

- Instant App Access
- HTML5 for Chrome OS
- Accelerated graphics performance
- Improved USB Integration
- Virtual IP loopback
- HDX Mobile SDK v2
- HDX RealTime Optimization Pack for Lync



The Native User Logon Process

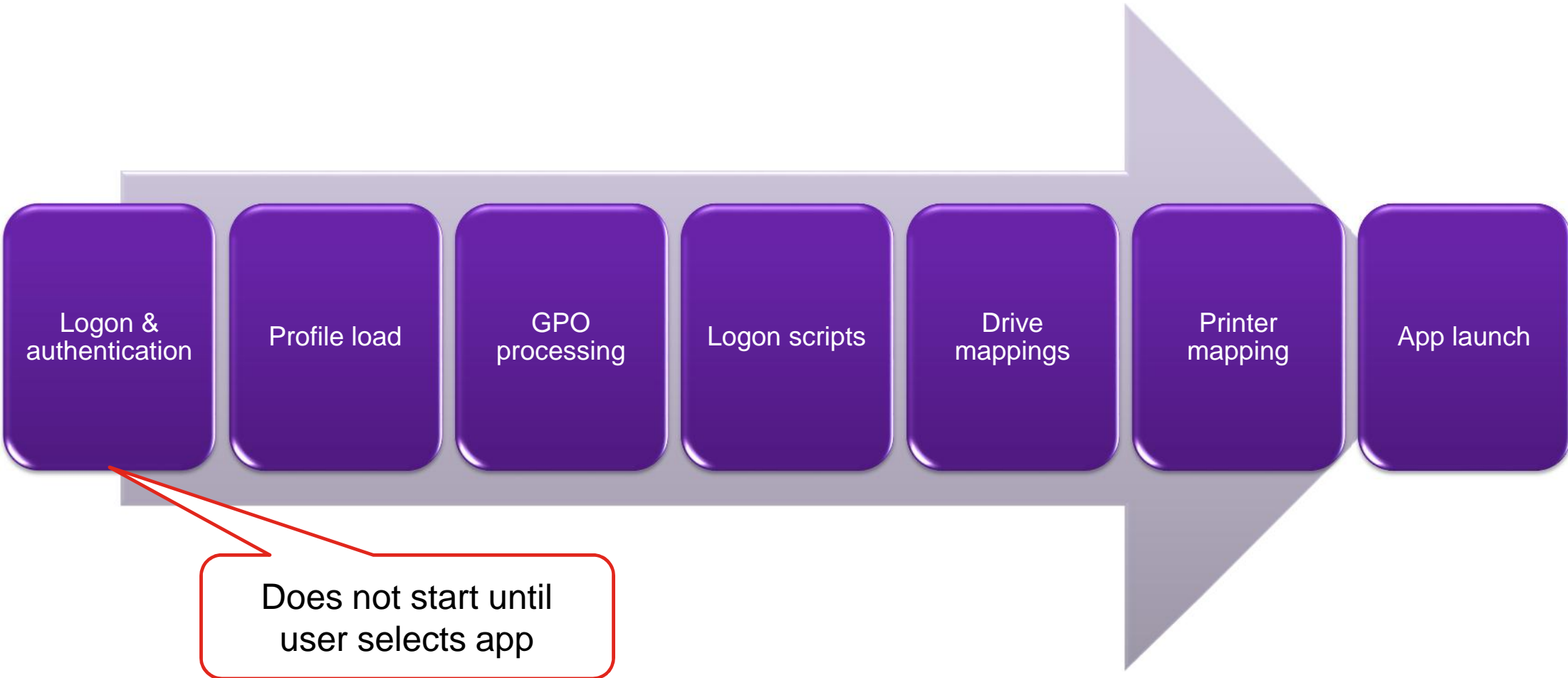

Instant App Access

A simple, two pronged approach

Application Prelaunch

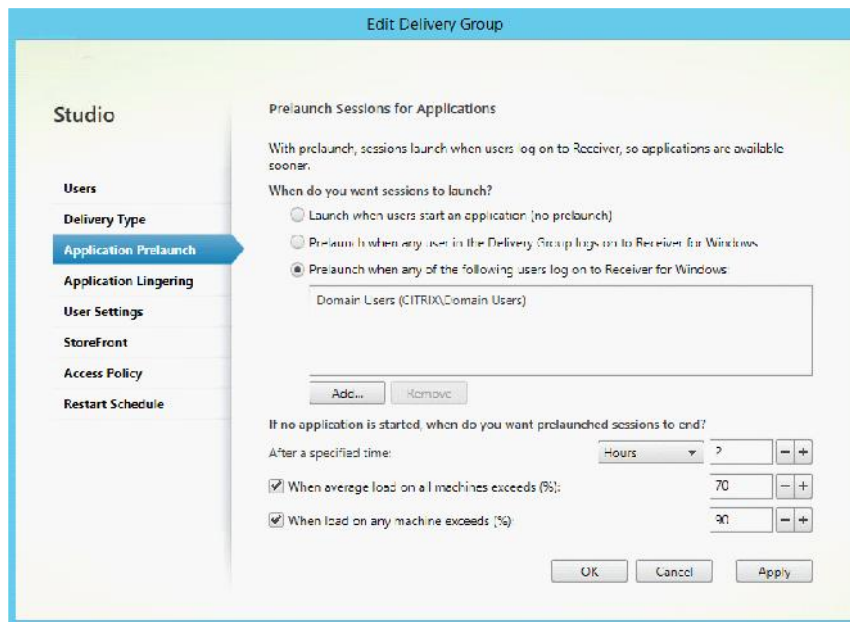

How it works:

- When user logs into Receiver, starts a XenApp session with “dummy” app
- Session remains until time expires or load too high
- User selected app immediately starts in same session

Why it is good:

- Eliminates more than 90% logon time
- No long logon duration complaints
- User experiences instantaneous app launches

Instant App Access

A simple, two pronged approach

How it works:

- When user closes last app in a session, the session remains active
- Session remains until time expires or load too high

Why it is good:

- Users often close an app before starting another app
- Eliminates constant log off/on scenarios
- Provides a more desktop-like experience

Application Lingering

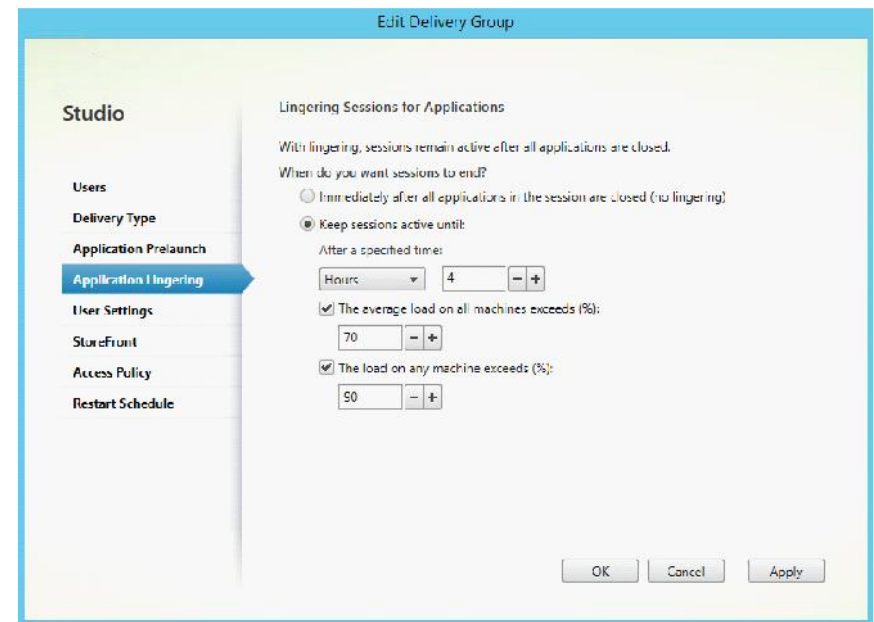

The XenApp 7.6 User Logon Process

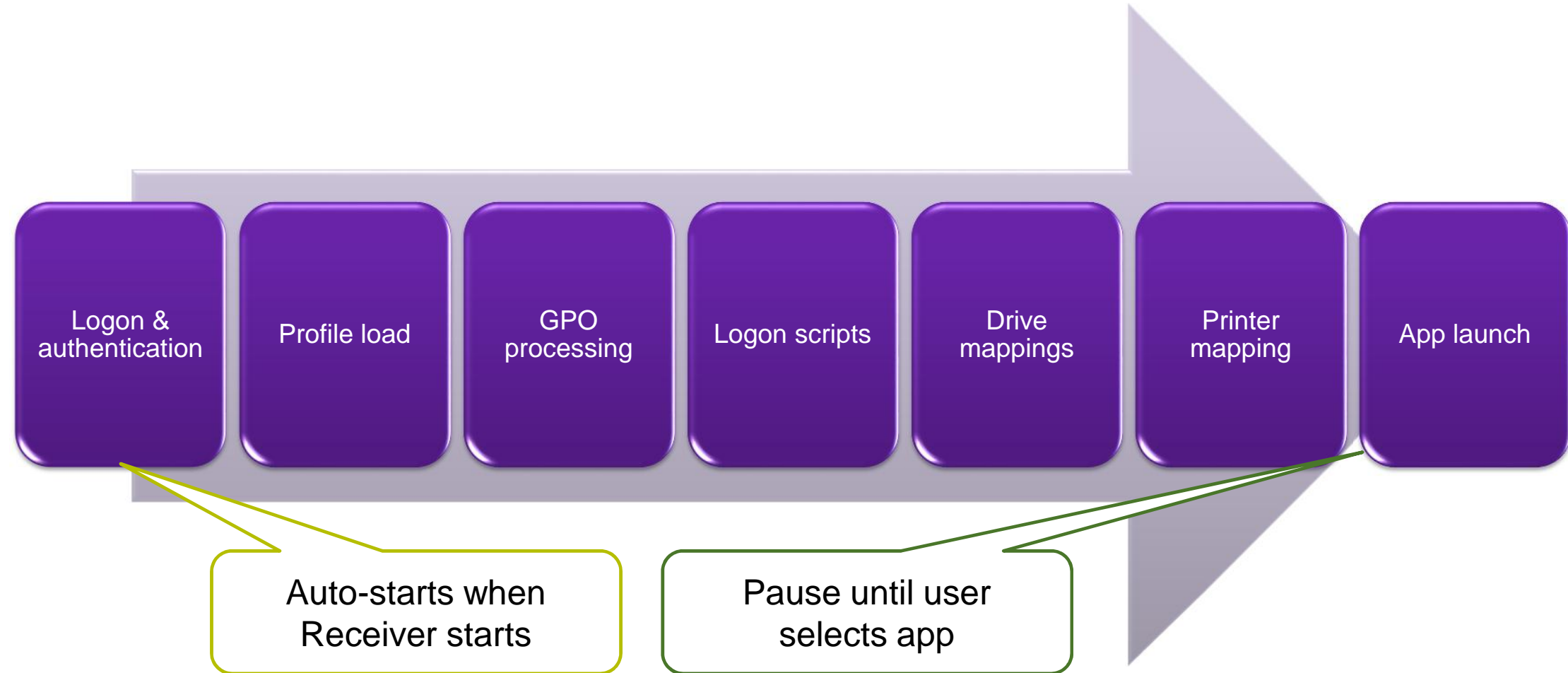

Generic USB redirection for XenApp

New for XenApp 7.6!

USB redirection for XenApp (RDS) and UBS 3.0

Single hop, full published desktops

Will enable 3DConnexion Space Mouse on XenApp



Virtual IP Loopback

How it works:

- XenApp server allocates unique IP address to each session
- Entire session or specific apps

Why it is good:

- Better app compatibility
- Improved network monitoring
- Granular policy

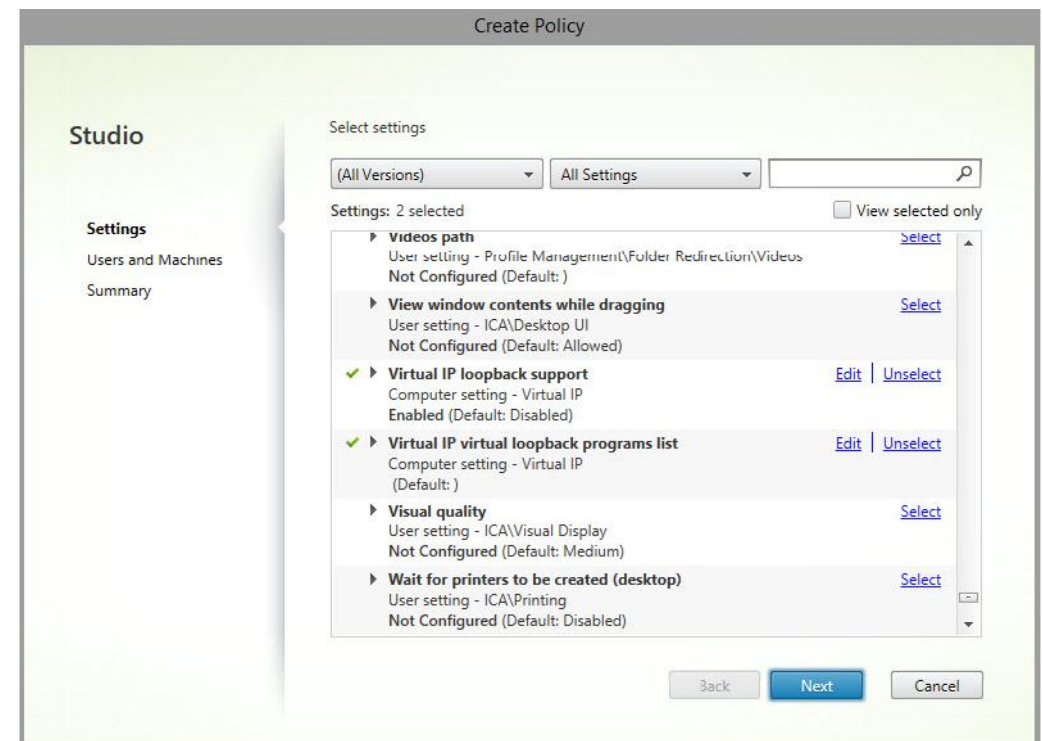

Key Highlights of StoreFront 2.6

Enriching the XenApp and XenDesktop user experience

Increased Usability

- Improved Receiver for HTML5 (apps & desktops)
- Receiver for Web access on mobile browsers
- My Apps folder
- Simplified configuration
- FQDN

Extended Functionality & Security

- XenApp & XenDesktop 7.6 updates
- Advanced RSA Adaptive Authentication
- Extensible authentication SDK
- Smart Card authentication options
- Kerberos constrained delegation for XenApp 6.5





HTML5 Receiver & Receiver for Chrome





Anonymous Access

Fast, secure access to healthcare apps

Healthcare professionals need fast, instant access to healthcare apps

- No user logon process
- Two-step admin configuration
- Unauthenticated (anonymous) and authenticated apps, together
- Troubleshoot issues with Director

Unauthenticated (Anonymous) Access

Delivery Group

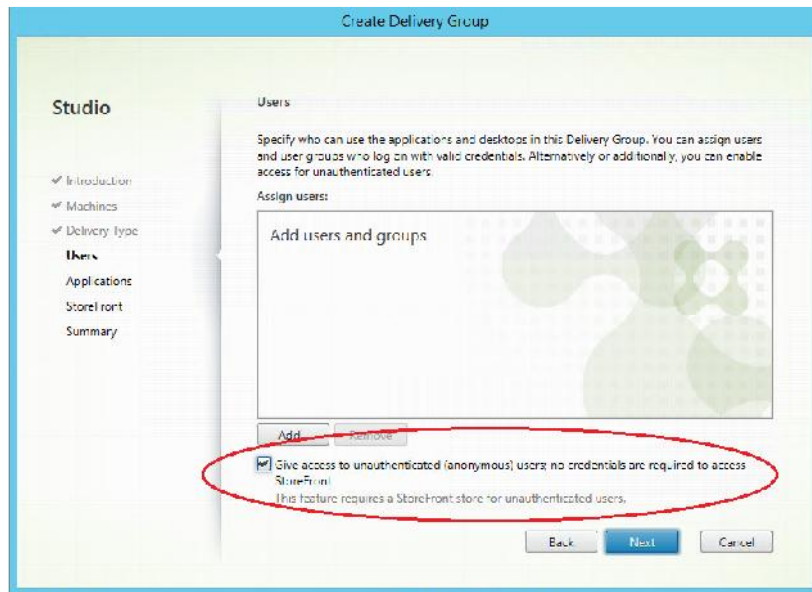

Store

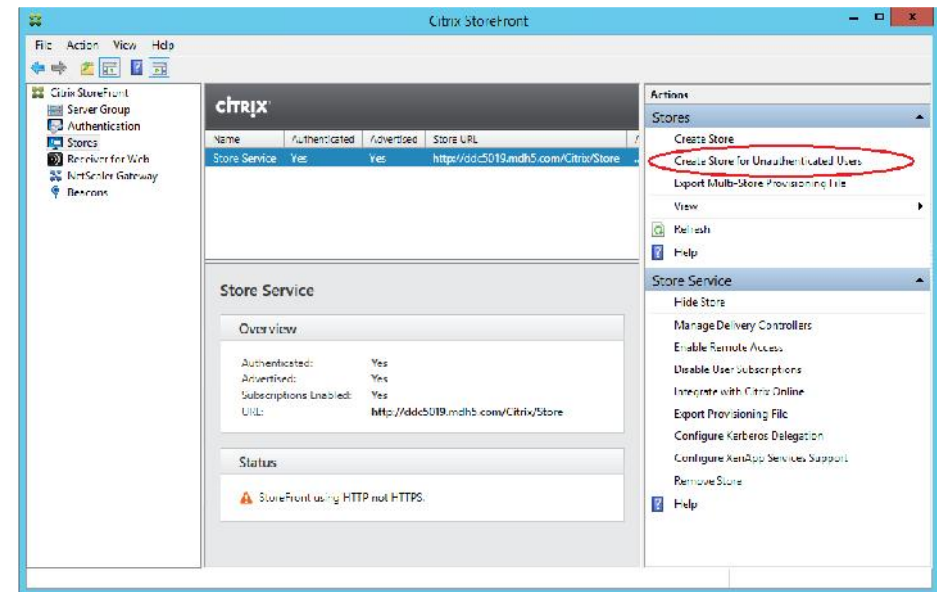

HDX RealTime: Complementary approaches

Generic: Media-over-ICA

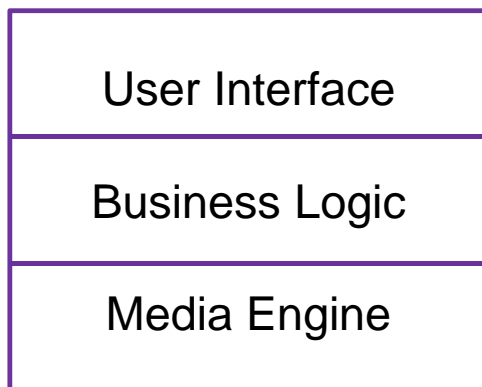

unmodified
softphone
architecture

Optimized: Peer-to-peer

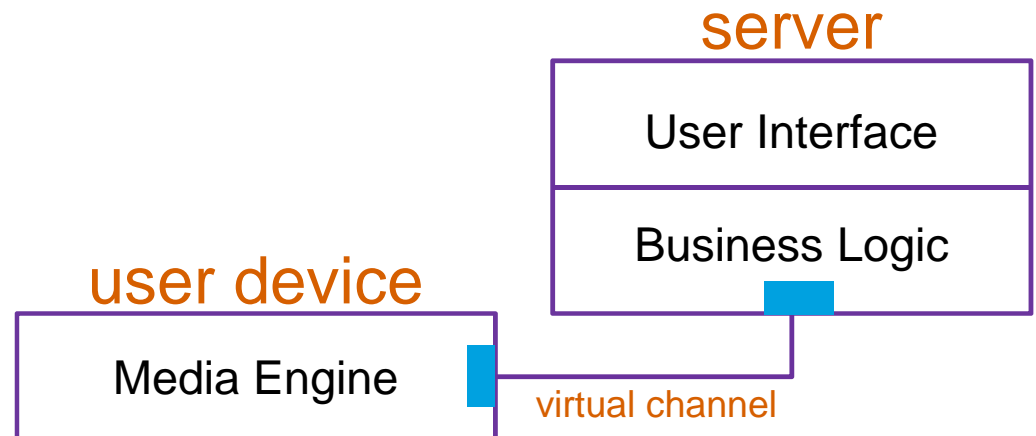

modified softphone
architecture

Optimization Pack Compatibility Matrix – Skyfall

Software Component	Version Number
Citrix Servers	
XenDesktop (Win 7, 8.1)	5.6, 7.x – Enterprise, Platinum
XenApp (Win Server 2008 R2, 2012 [R2])	6.5, 7.x – Enterprise, Platinum
VDI-in-a-Box	5.2 and above
User Devices	
Windows	7, 8.1, Thin PC, XPe, WES7
Linux	Ubuntu, Fedora Red Hat, SUSE, CentOS
Mac	10.9, 10.10
Microsoft Lync	
Lync client	Lync 2010 (32-bit)
Backend Lync infrastructure (Front-End Server, Edge Server, A-V Conferencing Server, etc.)	Lync Server 2010, Lync Server 2013

© Citrix – CONFIDENTIAL – *The development, release and timing of any features or functionality described for our products remains at our sole discretion and are subject to change without notice or consultation. The information provided is for informational purposes only and is not a commitment, promise or legal obligation to deliver any material, code or functionality and should not be relied upon in making purchasing decisions or incorporated into any contract.*



Improved Security

Improved Security

Worldwide recognition as the industry standard for app security

XenApp & XenDesktop are **FIPS compliant**, simplifying highly regulated compliance

**FIPS 140-2
Compliant
&
Common Criteria
evaluation**

SSL to VDA Encryption

XenApp & XenDesktop has achieved **Common Criteria** evaluation milestone, first & only in industry

Granular Clipboard Security

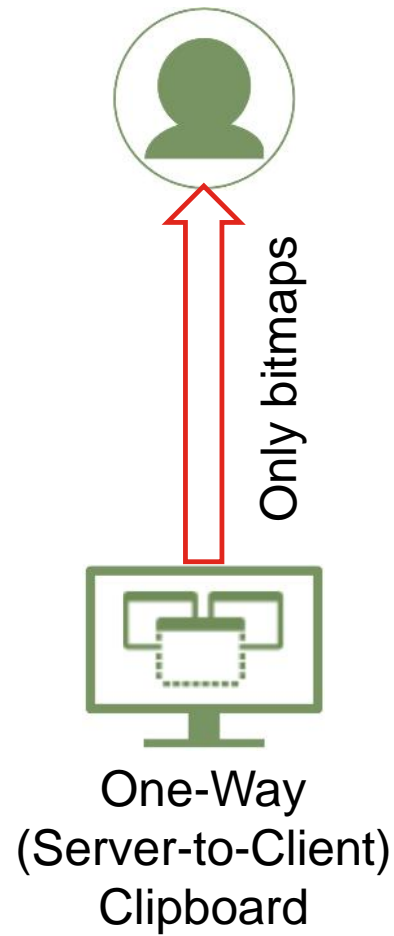
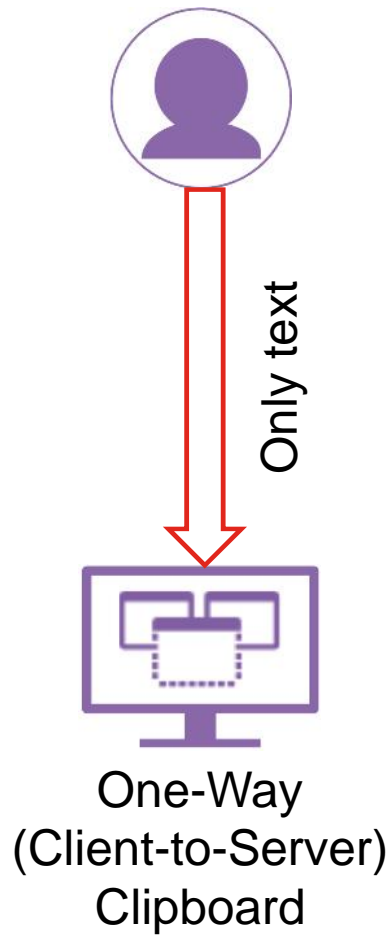
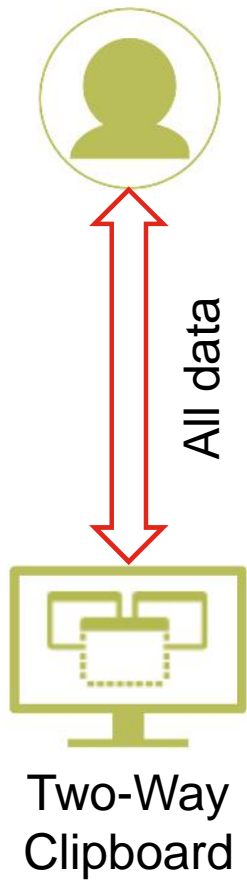

Clipboard Control

Clipboard Restriction Policy

Edit Setting

Restrict session clipboard write
Applies to: Virtual Delivery Agent: 7.6 Server OS, 7.6 Desktop OS

Allowed
This setting will be allowed.

Prohibited
This setting will be prohibited.

▼ **Details and related settings**

When this setting is set to Enabled, client clipboard data cannot be shared within the user session. Administrators could selectively allow some formats by enabling the setting "Session clipboard write allowed formats".

Related Settings:
Client clipboard redirection, Session clipboard write allowed formats, Restrict client clipboard write, Client clipboard write allowed formats

OK Cancel

Clipboard Content Policy

Edit Setting

Session clipboard write allowed formats
Applies to: Virtual Delivery Agent: 7.6 Server OS, 7.6 Desktop OS

Values:

Use default value:

▼ **Details and related settings**

This setting doesn't apply if "Client clipboard redirection" is set to Prohibited or "Restrict session clipboard write" is not set to Enabled.

When the setting "Restrict session clipboard write" is set to Enabled, client clipboard data cannot be shared with session applications but this setting can be used to selectively allow specific data formats to be shared with session clipboard. Administrators can enable this setting and specify the formats to be allowed.

The followings are system defined clipboard formats:
CF_TEXT
CF_BITMAP
CF_METAFILEPICT
CF_SYLK



Simplified Management

Background on IOPS

The good and the bad

Good and Bad IOPS

Sequential Access

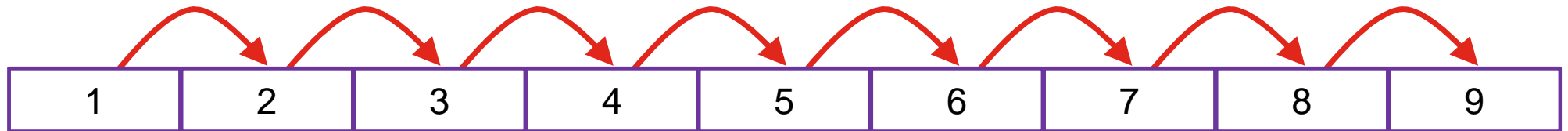

Random Access

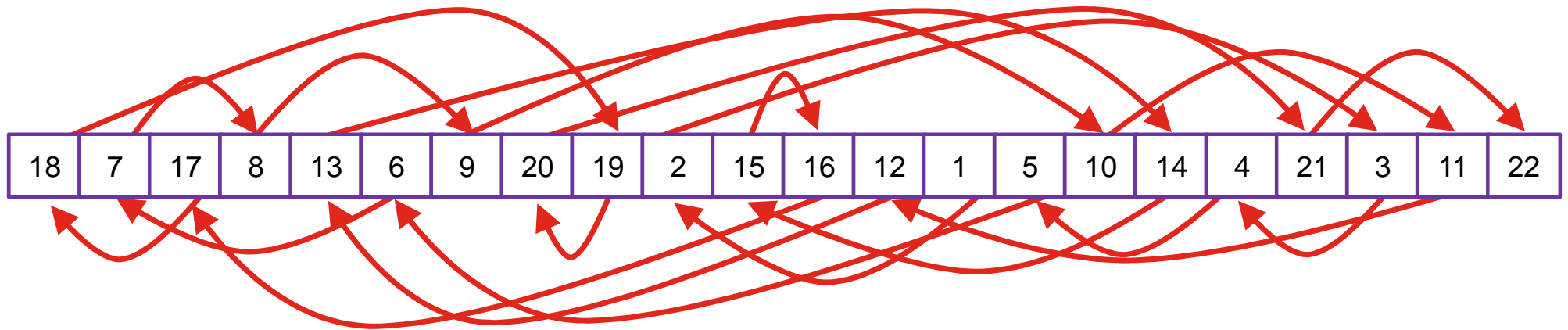

The XenApp & XenDesktop 7.6 Approach to IOPS

Place small, random writes in RAM

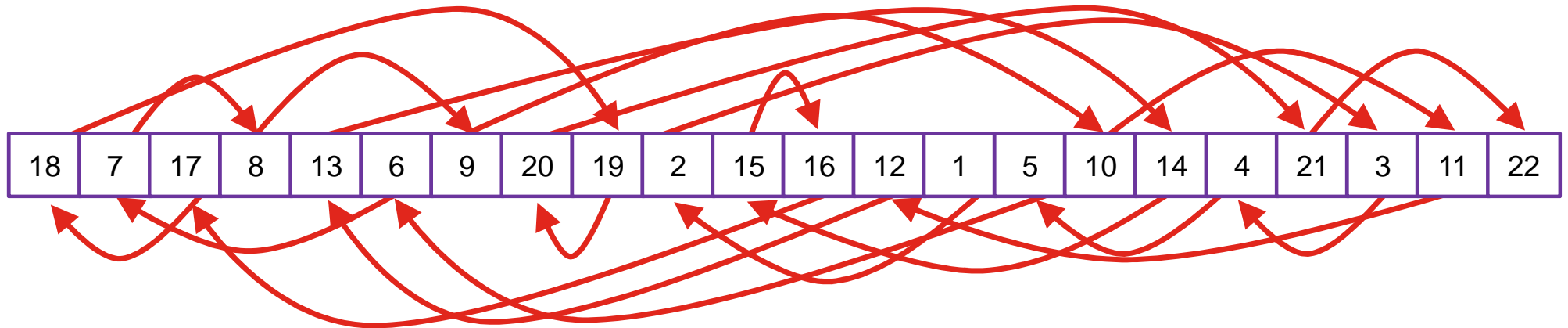

As RAM consumed, sequence and write larger blocks to disk

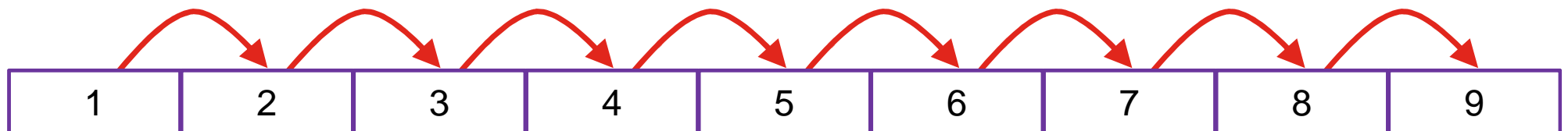

XenDesktop eliminates over **90%** of the IOPS without any extra storage hardware.
(RAM Cache with Overflow on Disk Cache)

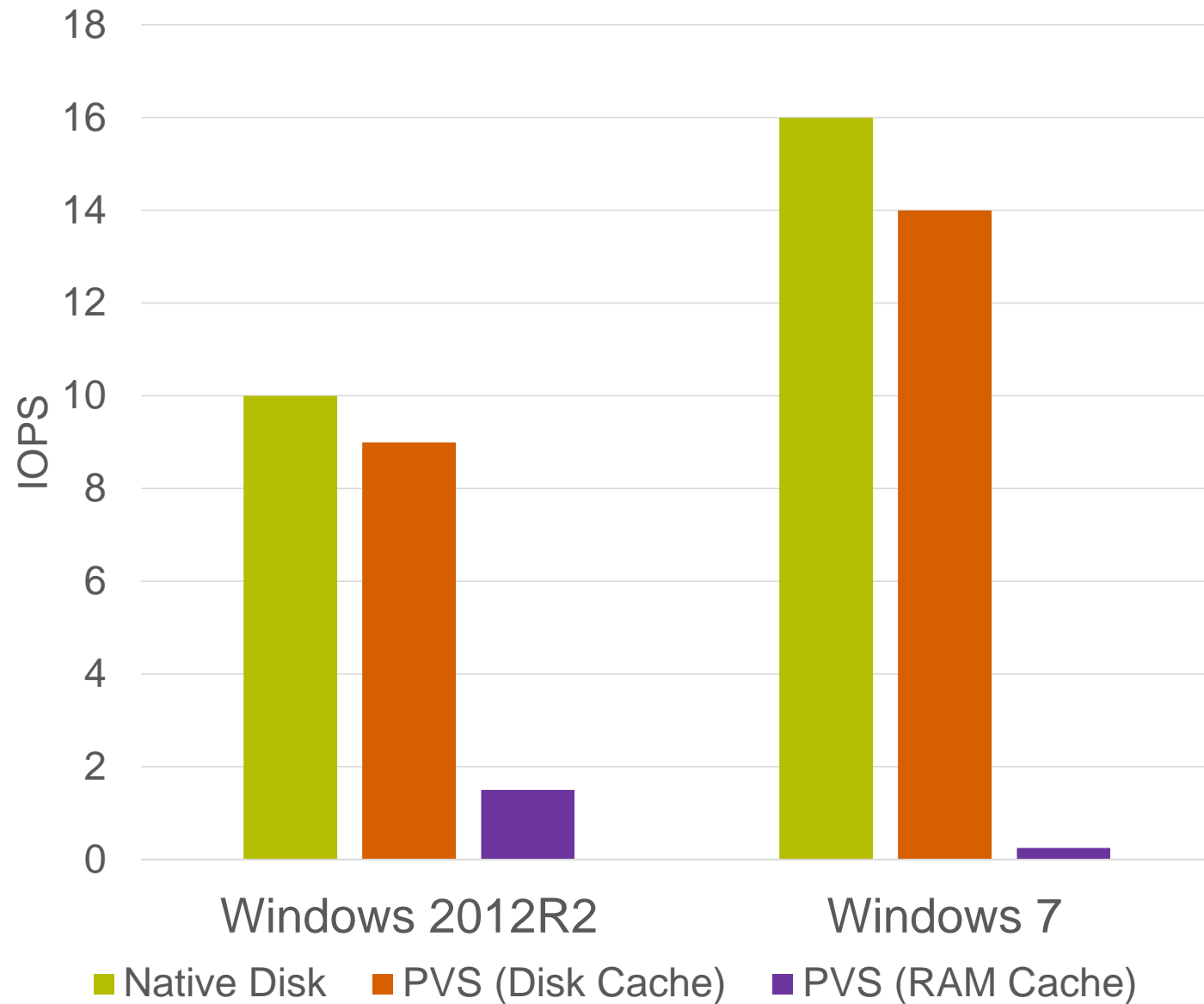

Connection Leasing

A safety net for your users

Pre-XenApp 7.6

Normal operations

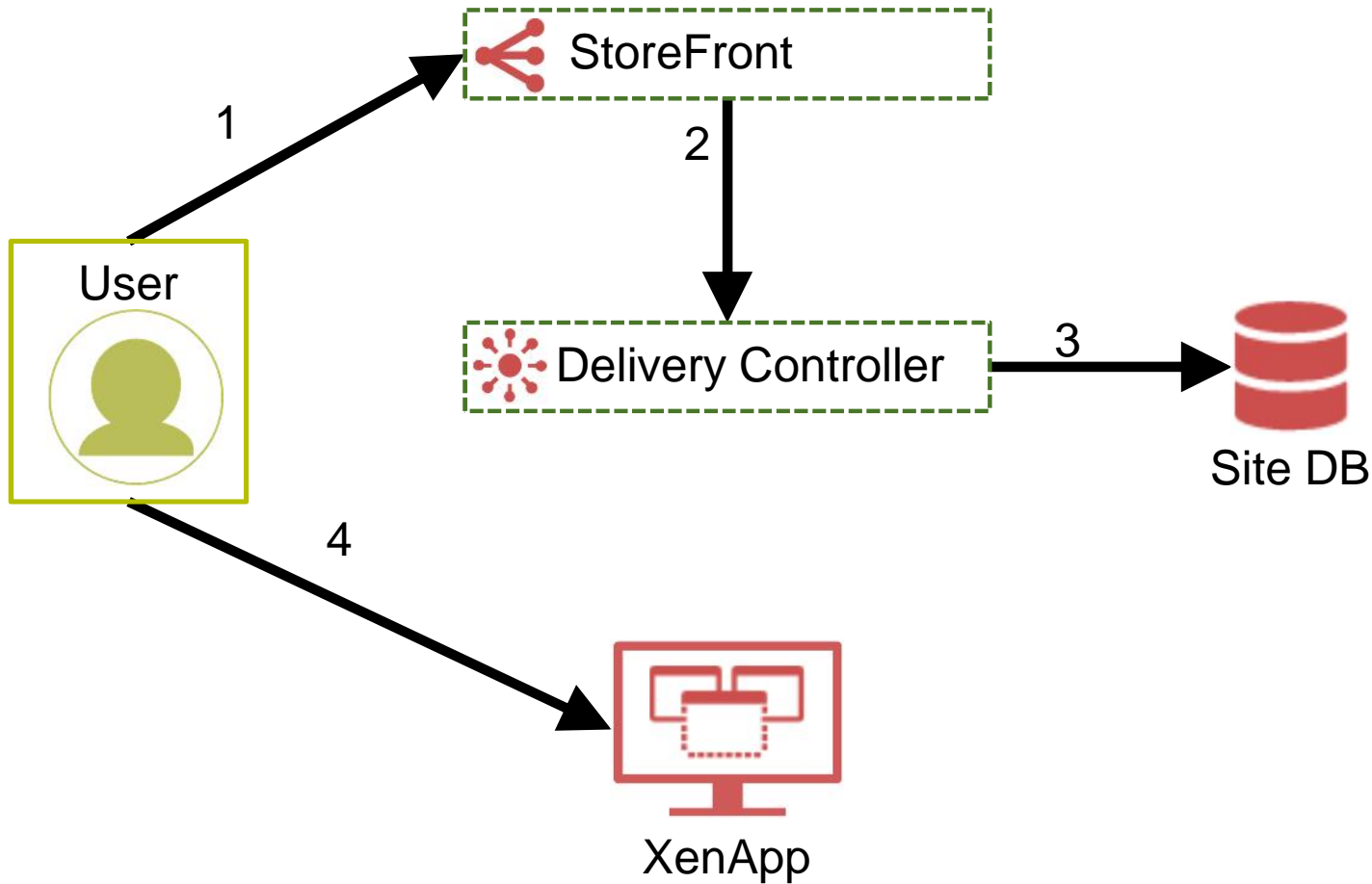

1. User authenticates to StoreFront
2. StoreFront forwards credentials
3. Controller authenticates user and enumerates resources via the DB
4. Receiver receives response and starts session

Pre-XenApp 7.6

Database outage

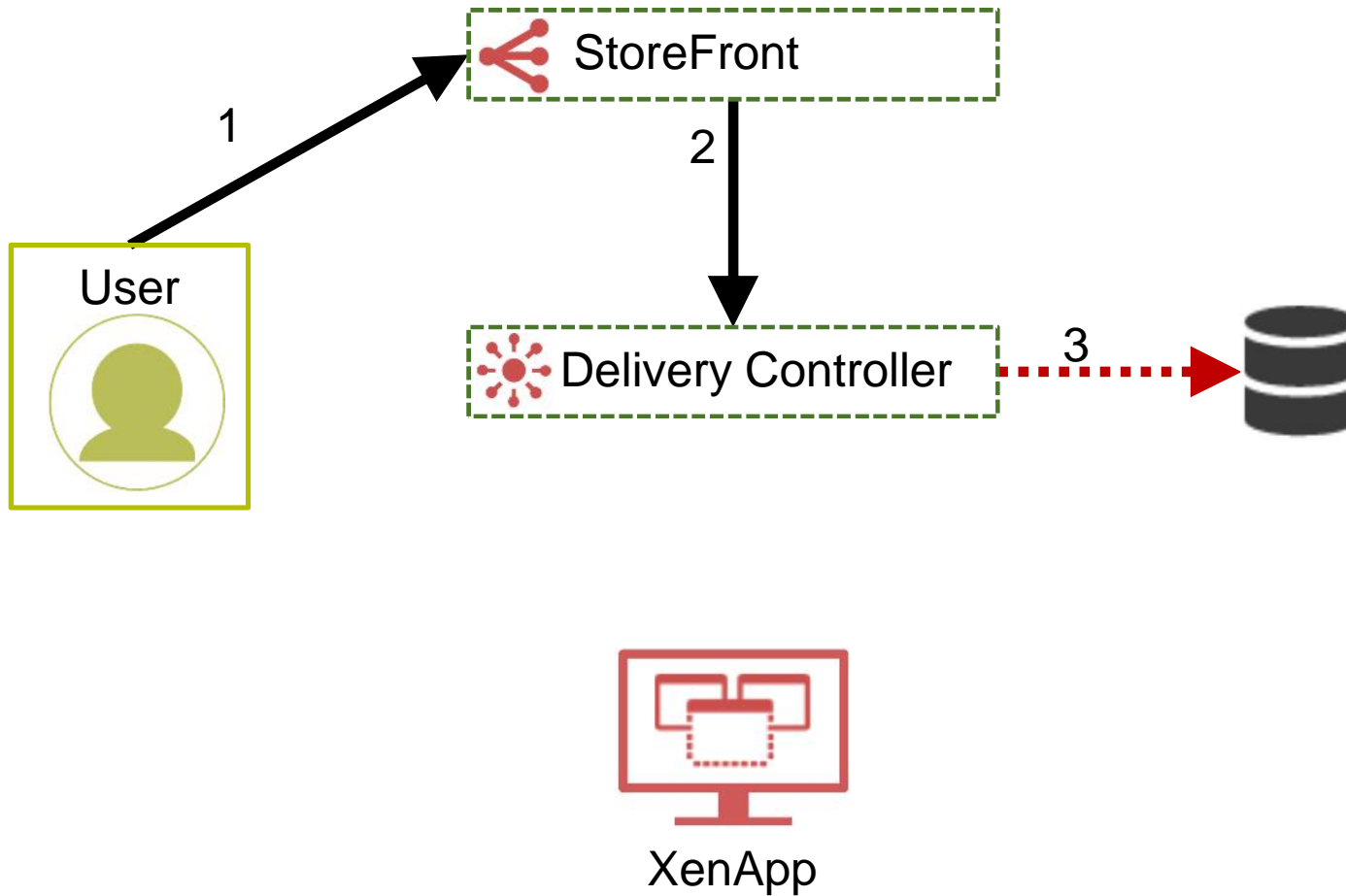

1. User authenticates to StoreFront
2. StoreFront forwards credentials
3. Controller authenticates user and fails to enumerate resources as DB is offline
4. User cannot start session

XenApp 7.6

Normal Operations

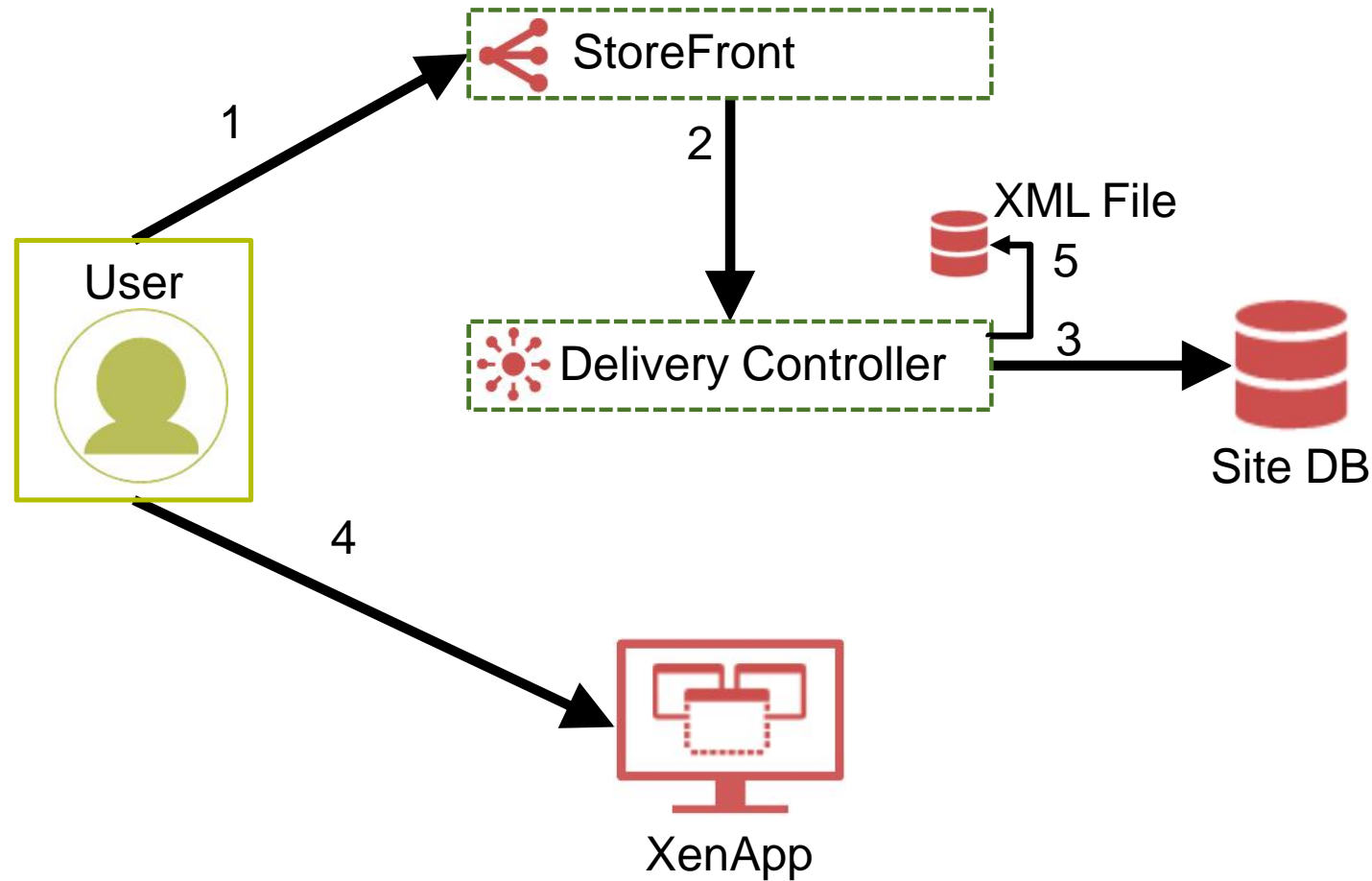

1. User authenticates to StoreFront
2. StoreFront forwards credentials
3. Controller authenticates user and enumerates resources via the DB
4. Receiver receives response and starts session
5. Controller logs resource access in local XML file

XenApp 7.6

Database outage

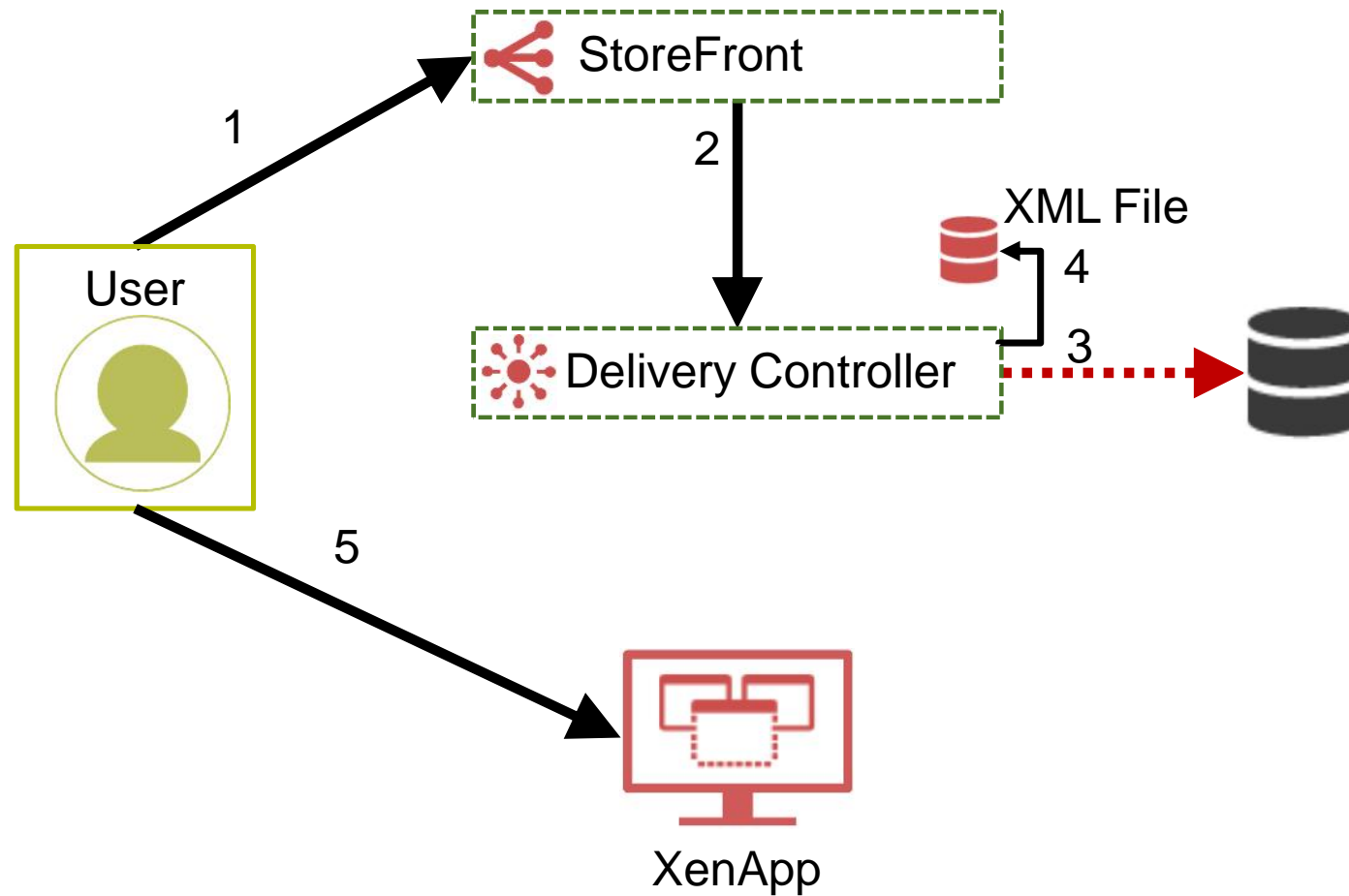

1. User authenticates to StoreFront
2. StoreFront forwards credentials
3. Controller authenticates user and fails to enumerate resources as DB is offline
4. Controller accesses local XML file and enumerates resources
5. Receiver receives response and starts session



The image management challenge

AppDNA 7.6 simplifies App Migration for Windows EOL

A robust tool integrated into XenApp and XenDesktop Platinum

What's New

Dependency Mapping

Interoperability Testing

Build Assessment

WorxWeb Compatibility Analysis

Name	Manufacturer	Version	64 Bit 64bit Manager	Server 2008 R2 SP1	Server 2008 SP2	Server 2012	Server Compatibility Manager	Windows 7 SP1	Windows 8	Desktop Compatibility Manager	Yamaha Method SEC Manager	App-V	XenApp Streamed	Virtualization Manager	Interoperability Security Manager	Firefox	IE	WebApp Compatibility Manager	Compendy RAG	Overall RAG
1 自研実用	ジヤクダン株式会社	5.14.0006	A	A	R	A	R	G	G	R	A	R	R	G	U	U	U	R		R
2 XenCenter	Citrix Systems, Inc	5.0.0	G	A	R	A	R	A	A	G	A	A	A	G	U	U	U	R		R
3 VZAccess Manager Enterprise	Smith Micro Software Inc.	6.10.0	R	R	R	R	R	R	R	G	A	A	A	G	U	U	U	R		R
4 StyleWriter	Editor Software	3.90	R	R	R	R	R	R	R	A	A	A	A	G	U	U	U	R		R
5 Microsoft Office Communicator Web Access インストール	Microsoft Corporation	1.0.0.0	G	G	R	R	R	G	G	G	A	A	A	G	U	U	U	R		R
6 MetaFrame Presentation Server クライアント	Citrix Systems, Inc.	9.150.39151	A	R	R	R	R	G	G	G	A	A	A	R	U	U	U	R		R
7 MetaFrame Password Manager Agent	Citrix	4.0.266.0	R	R	R	R	R	R	R	R	G	G	G	R	U	U	U	R		R
8 Lotus Notes 6.5 ja	IBM	6.50.3261	A	R	R	R	R	R	R	A	A	A	A	A	U	U	U	R		R
9 DameWare NT Utilities	DameWare Development	3.72.0.0	R	R	R	R	R	R	R	G	A	A	A	G	U	U	U	R		R
10 Citrix XenApp Plugin for Hosted Apps	Citrix Systems, Inc.	11.0.0.5357	A	R	R	R	R	R	R	A	A	A	A	R	U	U	U	R		R
11 Citrix Streaming Profiler 1.2 for Windows	Citrix Systems, Inc.	5.0.0.5357	R	R	R	R	R	R	R	G	R	R	R	R	U	U	U	R		R

Free AppDNA Training Course
<http://training.citrix.com/mod/ctxcatalog/course.php?id=857>



The right alerts, reports and tools for Support

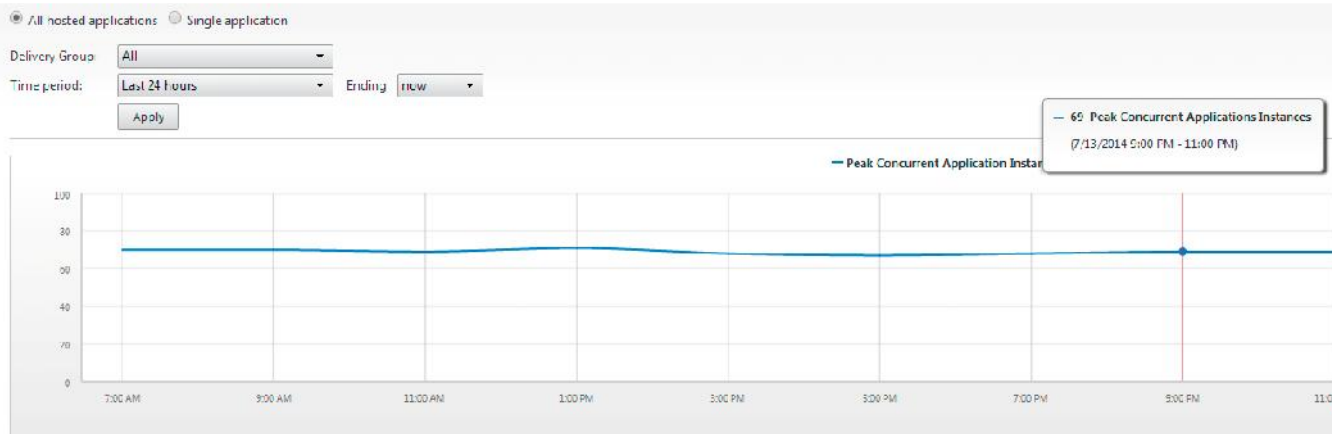

Application Usage Reporting

Licensing Alerts

User Connection Failures 0 Failed Desktop OS Machines 0 Failed Server OS Machines 0 Licensing Status 2 Data updated every minute

License Server
As of 6/11/2013 11:53 AM

▲ **Licenses are about to expire.**
 Some product licenses will expire in %d day(s).

✔ **Recommended Action**
 Purchase and allocate product licenses.

Delivery Controller
As of 6/11/2013 11:53 AM

- sc-exc-ddc-02.xendesktop.eng.citrite.net

Overview
Details
- ✔ uk-exc-ddc-02.xendesktop.eng.citrite.net

Overview
Details
- ✔ ftl-exc-ddc-03.xendesktop.eng.citrite.net

Overview
Details

- Error checking out a connection license. Check license server connectivity.
 Last licensing event time: 11/21/2013 11:53 AM (For more details check event log)

License Server Address:	'%61'
License Server Port:	'%62'
Desktop ID:	'%63'
User:	'%64'

Hotfixes

Component	Component Version	Hotfix Name	Hotfix File Name	Knowledge Center	Effective Date
Virtual Desktop Agent - x64	7.0.100.20	XD700YDAx64	Broker_Service_x64.msi	CTX135901	12/29/2013 9:23 PM
Citrix Director VDA Plugin	7.0.100.23	XD700DDPluginx64	Director/VDAPLugin_x64.msi	CTX236931	12/27/2013 9:23 PM
Virtual Desktop Agent - x86	7.0.200.20	XD700YDX85	BrokerAgent_x85.msi	CTX135931	12/25/2013 9:23 PM

Hotfix Inventory

Simplifying App Management and Monitoring

Enhancements to Citrix Studio and System Center integration

App Folders



Citrix Connector

Deploy software to XenApp & XenDesktop

Create published apps using Conf Manager

Operational enhancements like user logoff

Support Citrix provisioning (PVS and MCS)

Unified policy control for published app, MSI and App-V



HP Moonshot for XenDesktop and XenApp

Simplify application and desktop delivery

HP Moonshot with Citrix XenApp and XenDesktop

Application Delivery

HP ProLiant m710



4 Xeon cores,
integrated GPU,
10Gb networking

CITRIX
XenApp

Delivering a broad range of **hosted applications**

Scale efficiently to deliver a range of applications - from productivity to audio/video to graphics

Hosted Desktop Infrastructure¹

HP ProLiant m700



4 PC's per
cartridge with
integrated GPU

CITRIX
XenDesktop

Delivering **hosted desktops**

Predictable desktop performance from dedicated server to end user with up to 6x faster graphics frames per second¹

One common platform

Gain control & reduce complexity

Fewer components to manage with significantly less cabling

Accelerate business innovation

Host more apps and desktops in the data center

Realize breakthrough economics

Reduce OpEx with fixed cost per user and CapEx with no virtualization layer or SAN





XenApp / XenDesktop Feature Matrix

XenApp/XenDesktop 7.6 Feature Matrix

Meet the demands of any use case

	XenApp Advanced	XenApp Enterprise	XenApp Platinum	XenDesktop VDI	XenDesktop Enterprise	XenDesktop Platinum
XenApp published apps (Server-based hosted apps) can be deployed on 5 generations of Windows operating systems, enabling secure access to Windows apps on any type of device including iOS, Android, Mac and Windows devices for on-demand access from anywhere, lets users focus on work.	✓	✓	✓		✓	✓
XenApp published desktops are low-cost, locked-down virtual desktops that provide the flexibility and mobility benefits of desktop virtualization while maximizing IT control through enhanced security and simplified management.	✓	✓	✓		✓	✓
VDI desktops offer maximum user personalization of a persistent Windows virtual desktop that can be fully customized to meet the needs of your most-demanding users.				✓	✓	✓
VDI with Personal vDisk pairs the maximum user personalization benefits of VDI with the storage optimizations and administrative efficiencies of single image management to deliver a desktop virtualization solution that meets the needs of both users and IT admins.				✓	✓	✓

XenApp/XenDesktop 7.6 Feature Matrix

<p>Server VDI enables enterprises and service providers the ability to deliver to an individual user a single session, server-based virtual desktop from the cloud.</p>					✓	✓
<p>Hosted physical desktops enable high performance remote access to physical desktops securely protected in the datacenter for optimal data protection, especially beneficial for graphically intensive applications that run best on a native OS that has direct access to the physical desktop hardware.</p>					✓	✓
<p>Remote PC Access (with Wake On LAN) instantly delivers desktop virtualization benefits without the need to migrate desktops to the datacenter by providing users with a secure, high-definition, direct connections to their office PCs.</p>					✓	✓
<p>Offline client virtualization (XenClient Enterprise) extends the benefits of desktop virtualization to people who need to work from anywhere including offline, by enabling them to work in a disconnected state thereby extending use case flexibility.</p>					✓	✓
<p>DesktopPlayer for Mac (Add-on*) extends the benefits of XenDesktop to MacBook users, enabling them to run Windows desktops on a Mac whether they are online, offline, or even experiencing a slow or intermittent network connection. End users gain freedom while IT gains control by centrally managing Windows virtual desktops deployed to corporate and BYO MacBooks.</p> <p>*Add-on purchase required</p>					✓	✓

XenApp/XenDesktop 7.6 Feature Matrix

<p>VM hosted apps ease Windows OS transitions and overcome application compatibility challenges in a multi-user, server environment.</p>		✓	✓		✓	✓
<p>Pre-launch technology creates a local-like app launch experience by expediting the session creation process. With pre-launch, a session waits for the user in an active or disconnected state, enabling quick, instant-on app access to an already active app session making for a fast and local-like app launch experience. Pre-launch configurations have been improved on the FMA platform, making it simple to configure from the Citrix Studio management console.</p>	✓	✓	✓		✓	✓
<p>Session linger keeps the user session open after the user closes the app, to provide a quick app reconnect or enable the user to open a new app without repeating the logon process. Admin-configurable time-based policy automatically releases a license consumed by a pre-launched and lingering session to improve license management.</p>	✓	✓	✓	✓	✓	✓
<p>Anonymous Logon (unauthenticated user) enables instant, unauthenticated access to a single app while access to other, more personalized apps such as email remains authenticated.</p>	✓	✓	✓	✓	✓	✓
<p>USB 3.0 ready, enabling new Receivers coming for Windows and Linux to include automatic device mapping and provide users with a plug-n-play capability with the latest 3.0 devices such as web cams, microphones, headsets and other peripherals to enhance the user experience.</p>	✓	✓	✓	✓	✓	✓

XenApp/XenDesktop 7.6 Feature Matrix

Increase employee productivity with high performance anywhere access

	XenApp Advanced	XenApp Enterprise	XenApp Platinum	XenDesktop VDI	XenDesktop Enterprise	XenDesktop Platinum
<p>HDX™ user experience optimization delivers a superior high-definition user experience on any device, over any network. With Citrix HDX, the virtual experience rivals a local PC, even when using multimedia, real-time voice and video collaboration, USB peripherals and 3D graphics. Virtual Windows apps become mobile device aware and optimized to support touch gestures and other native mobile device features. Integrated WAN optimization capabilities boost network efficiency and performance even over challenging, high-latency networks.</p>	✓	✓	✓	✓	✓	✓
<p>HDX™ Mobile optimizes Windows apps for mobile devices including multi-touch- and gesture-enabled smartphones and tablets while enhancing performance over mobile networks by intelligently coping with the variability and packet loss of mobile networks and supporting the decompression of graphics and multimedia with hardware acceleration on tablets and smartphones. HDX Mobile SDK enables developers to make any custom Windows app mobile-device aware by enabling device features, camera/video, microphone and GPS features to integrate with the virtual app.</p>		✓	✓		✓	✓
<p>HDX Seamless local apps blend a locally installed application on the Windows endpoint into a virtual desktop, providing a seamless user experience.</p>			✓			✓

XenApp/XenDesktop 7.6 Feature Matrix

<p>HDX 3D Pro™ brings app and desktop virtualization to remote office employees, 3rd party contractors, and even mobile tablet that depend on graphically intense 3D applications. Bringing enhanced security to intellectual property while promoting better collaboration and real-time editing in the field. Best of all, the enormous data files required to generate complex designs all remain safe in the datacenter keeping all users in sync without complex and costly data synchronization.</p>		✓	✓		✓	✓
<p>XenServer vGPU sharing provides the best possible graphics experience when virtualizing 3D applications. Only XenServer allows NVIDIA drivers to be loaded directly into the hypervisor to ensure proper management of graphical application performance in a virtual app and desktop scenario.</p>		✓	✓		✓	✓
<p>Unified Communications optimization seamlessly integrates solutions from Microsoft, Cisco, Avaya, and Vidyo to deliver real time communication applications with “local PC” quality without having to increase bandwidth investments with built-in optimized point to point transfer of voice and video traffic.</p>	✓	✓	✓	✓	✓	✓
<p>HDX RealTime Optimization Pack for Lync delivers clear, crisp high-definition video and voice communications for Microsoft Lync within a virtual desktop or as a published application on Windows, Mac and Linux devices.</p>		✓	✓		✓	✓

XenApp/XenDesktop 7.6 Feature Matrix

<p>WAN optimized XenApp and XenDesktop delivers a superior user experience even over low-bandwidth, high latency connections. Citrix HDX technology can intelligently detect bandwidth capacity and dynamically transform communication on the fly.</p>	✓	✓	✓	✓	✓	✓
<p>CloudBridge VPX for WAN optimization significantly improves XenDesktop and XenApp capacity and performance over the WAN while providing a unified platform that accelerates applications across public and private networks, resulting in superior application performance and end user experience.</p>						✓
<p>CloudBridge plug-in software-based, network accelerator client that runs on Windows laptops and workstations anywhere offering accelerated app performance from anywhere, not just offices with CloudBridge appliances.</p>			✓			✓

XenApp/XenDesktop 7.6 Feature Matrix

Simplify support and enable choice of BYO device

	XenApp Advanced	XenApp Enterprise	XenApp Platinum	XenDesktop VDI	XenDesktop Enterprise	XenDesktop Platinum
Any device access empowers employees to choose the devices that are right for them and their work style with a universal client that works natively on the broadest range of desktops, laptops, tablets and smartphones to ensure device investment protection without added work for IT.	✓	✓	✓	✓	✓	✓
Enterprise app store powered by StoreFront empowers users with self-service selection of their authorized apps and desktops, delivering a consistent experience across different devices and networks, and quickly reconnecting users for speed and convenience.	✓	✓	✓	✓	✓	✓
Clientless HTML 5 Receiver offers a clientless access solution, making it easy to access virtual apps and desktops from any device include devices that are unable to install a physical client.	✓	✓	✓	✓	✓	✓
Universal Printing services mitigates the administrative burden associated with the management of hundreds or thousands of network and local printer drivers through centralized, universal printing services and further optimizes printing performance across local, mobile, and remote connections.	✓	✓	✓	✓	✓	✓
Support for 16-, 32-, 64-bit apps on Windows Server 2008R2 and 2012R2 and Windows 7/8 delivers a seamless user experience using any of five generations of Windows letting users focus on work, not juggling multiple desktops by supporting 16- & 32-bit apps on a desktop OS and 64-bit apps on a server OS.	✓	✓	✓		✓	✓

XenApp/XenDesktop 7.6 Feature Matrix

Protect sensitive information through centralization

	XenApp Advanced	XenApp Enterprise	XenApp Platinum	XenDesktop VDI	XenDesktop Enterprise	XenDesktop Platinum
FIPS compliant , helping IT administrators simplify security compliance and data protection by adhering to strict security compliance.	✓	✓	✓	✓	✓	✓
Common Criteria evaluation milestone achieved, used by 19 countries worldwide, with many more countries following the standards unofficially, XenApp and XenDesktop is the only app and desktop virtualization solution to be achieve such worldwide security recognition.	✓	✓	✓	✓	✓	✓
Centrally secured apps are protected in the datacenter and securely delivered on-demand to any user anywhere making it easy to keep sensitive information safe based on an inherently secure architecture.	✓	✓	✓		✓	✓
Centrally secured desktops are protected in the datacenter and securely delivered on-demand to any user anywhere making it easy to keep sensitive information safe based on an inherently secure architecture.	✓	✓	✓	✓	✓	✓
High security with XenApp and XenDesktop enables secure access from anywhere without exposing the corporate network. All mission-critical data remains protected in the datacenter unless it can be audited, controlled and enforced by policy. Only screen updates, mouse clicks and keystrokes-not data-traverse the remote connection keeping application data safe from hackers and protecting the corporate network from unmanaged devices.	✓	✓	✓	✓	✓	✓

XenApp/XenDesktop 7.6 Feature Matrix

<p>2-factor authentication support enhances secure access from anywhere through integrated solutions including RSA SecureID, RADIUS server, and Aladdin SafeWord for Citrix.</p>	✓	✓	✓	✓	✓	✓
<p>ICAProxy provides secure access to virtual Windows apps and desktops published on XenApp and XenDesktop while keeping apps, desktops and data safely protected within the datacenter without requiring a VPN.</p>	✓	✓	✓	✓	✓	✓
<p>Support for Risk-Based Authentication (Receiver), a powerful risk engine that transparently increases security by delivering user-friendly multi-factor authentication. Risk-Based Authentication ensures that users are who they say they are while preserving the familiar username/password login experience. IT can customize how authentication works with XenApp and XenDesktop, substantially enhancing the security of applications and desktops while providing a seamless end-user experience.</p>	✓	✓	✓	✓	✓	✓
<p>SmartAccess™ fine-grained context-based policy engine employs smart access policy management to balance the needs of varying use case scenarios by granting or denying individual tasks, such as printing, copy/paste or mapping drives, at a granular scenario-specific level. Provided with NetScaler Gateway Universal Licence included in Platinum.</p> <p>NetScaler Gateway appliance, priced separately.</p>			✓			✓
<p>SSL VPN provides secure remote access control from any device to all the corporate resources located on the internal network. Provided with NetScaler Gateway Universal Licence included in Platinum.</p> <p>NetScaler Gateway appliance, priced separately.</p>			✓			✓

XenApp/XenDesktop 7.6 Feature Matrix

<p>ShareFile integration with virtual apps and desktops for optimized on-demand, on or off-premise data sharing and sync service meeting the mobility and collaboration needs of users and the data security requirements of the enterprise.</p> <p>ShareFile priced separately.</p>	✓	✓	✓	✓	✓	✓
<p>Hosted MobileMail incorporates email, calendaring and contact features into a mobile-friendly Windows application that can be delivered securely to any mobile device with Citrix Receiver from an enterprise datacenter via Citrix XenApp or XenDesktop.</p> <p>Downloaded separately.</p>	✓	✓	✓	✓	✓	✓

XenApp/XenDesktop 7.6 Feature Matrix

Reduce cost and complexity of app and desktop management

	XenApp Advanced	XenApp Enterprise	XenApp Platinum	XenDesktop VDI	XenDesktop Enterprise	XenDesktop Platinum
Simple to deploy world-class app and desktop virtualization solutions. XenApp and XenDesktop provides a unified set of common management consoles to dramatically simplify and automate large scale deployments, including multi-tenant, and hybrid-cloud implementations.	✓	✓	✓	✓	✓	✓
Simplify operations with powerful monitoring and advanced analytics by EdgeSight. EdgeSight reports, trend analysis, and alerts can be customized and configured with Citrix Director. Citrix Director also delivers a unique and powerful role-based access that enables IT helpdesk and escalation teams to quickly troubleshoot and resolve issues making it easier for IT to meet stringent SLAs.	✓	✓	✓	✓	✓	✓
Custom Delegated Administration (Studio) gives large IT departments the ability to define the scope and role of administrative functions for compliance and control.		✓	✓		✓	✓
Configuration Logging (Studio) enables IT to monitor and track granular configuration changes to their app & desktop delivery infrastructure.		✓	✓		✓	✓
Hotfix Inventory gives visibility to the hotfixes installed on a VDA enabling IT to extend troubleshooting capabilities through identification of the hotfixes installed, improving the overall supportability.	✓	✓	✓	✓	✓	✓

XenApp/XenDesktop 7.6 Feature Matrix

<p>Hosted App Usage Reporting & Trending offers insight into published application usage through access to detailed reports that track app access by user, time spent within the app, and trends regarding most frequently used apps for a specified user, server or time period. With a better understanding of application usage, IT can better manage capacity in the environment.</p>			✓			✓
<p>App folders allows IT to better organize apps based on logical segmentation for simplified management for enterprises that have hundreds, even thousands, of published apps that are being managed.</p>	✓	✓	✓	✓	✓	✓
<p>Historical performance trending (EdgeSight) analyzes performance trends for proactive capacity planning and deployment optimization.</p>			✓			✓
<p>User experience network analysis (EdgeSight) provides user experience data supplied by NetScaler Insight Manager integrated into the EdgeSight console to correlate user performance and identify when network issues are disrupting performance.</p>			✓			✓
<p>Improved connection resiliency available through database connection leasing, which caches the results of successful users' connections for any number of days set by an admin. XenApp and XenDesktop can then reference this repository of secure connection information in the event of a database failure to ensure users can still connect to their published apps and desktops.</p>	✓	✓	✓	✓	✓	✓

XenApp/XenDesktop 7.6 Feature Matrix

<p>Hybrid cloud provisioning assures XenApp and XenDesktop may be deployed on popular Cloud management platforms including Amazon Web Services (AWS), or Citrix CloudPlatform-based public or private cloud services. From the Studio console, XenDesktop can assign workloads to traditional virtual infrastructure including Microsoft HyperV, VMware vSphere, and XenServer in the datacenter or provision apps and desktops from public, private or hybrid cloud infrastructure including Amazon Web Services, or any Citrix CloudPlatform-based cloud infrastructure making it easy for IT to meet their most demanding SLAs.</p>		✓	✓		✓	✓
<p>CloudPlatform integration for XenApp and XenDesktop hybrid cloud provisioning enables IT to dynamically provisioning app and desktop workloads from public, private and hybrid clouds leveraging Citrix CloudPlatform, powered by Apache CloudStack.</p>		✓	✓		✓	✓
<p>Amazon Web Services integration for XenApp and XenDesktop hybrid cloud provisioning enables IT to dynamically provisioning app and desktop workloads from the Amazon Web Services.</p>		✓	✓		✓	✓
<p>Automated app and desktop thin provisioning simplifies management of small and large deployments by centralizing image management while reducing the cost and complexity of shared storage.</p>	✓	✓	✓	✓	✓	✓

XenApp/XenDesktop 7.6 Feature Matrix

<p>Central image management of XenApp servers (Provisioning Services) simplifies management of small and large deployments of XenApp servers, physical or virtual, to support any type of use case while reducing the cost, complexity and amount of required shared storage. Dramatically simplifying the ability to patch and update physical and virtual servers with fast rollout and fast rollback functionality exclusive to Provisioning.</p> <p>*Provisioning Services for XenApp Enterprise is only available for VMHosted applications instances.</p>		✓*	✓		✓	✓
<p>Central image management of virtual desktops (Provisioning Services) simplifies management of small and large deployments of virtual and physical desktops to support any type of use case while reducing the cost, complexity and amount of required shared storage. Dramatically simplifying the ability to patch and update virtual desktops with fast rollout and fast rollback functionality exclusive to Provisioning Services.</p> <p>*Physical desktop support not available with the XenDesktop VDI Edition</p>				✓*	✓	✓
<p>Automated virtual machine provisioning (Machine Creation Services) assists with the management of small and large deployments of virtual machines, virtual desktops or virtual XenApp servers, to support any type of use case and reduces shared storage requirements.</p>	✓	✓	✓	✓	✓	✓

XenApp/XenDesktop 7.6 Feature Matrix

<p>Breakthrough image provisioning services delivers unprecedented storage performance—as much as a 20X improvement in read/write speeds—which greatly minimizes storage costs and complexity.</p>	✓	✓	✓	✓	✓	✓
<p>Powerful migration scripts simplify the move from XenApp 6.5 to XenApp 7.x by enabling select app settings, policies and folder structure into the new architecture.</p>	✓	✓	✓	✓	✓	✓
<p>Microsoft AppV integration automatically enables apps packaged with AppV technology to be managed in Studio and directly streamed from System Center to virtual desktops and XenApp servers, making it easy for IT to manage app consistency across the enterprise.</p>	✓	✓	✓		✓	✓
<p>Integrated Profile management (User Profile Manager) intelligently distinguishes user profile settings between active XenApp and XenDesktop session to ensure user settings are consistent and intelligently streams profile setting and data on-demand to expedite the user login process.</p>	✓	✓	✓	✓	✓	✓
<p>AppDNA™ application compatibility and migration software enables enterprises to confidently discover, automate, model and manage applications for faster application migration, easier application virtualization and streamlined application management.</p>			✓			✓

XenApp/XenDesktop 7.5 Feature Matrix

<p>Enterprise scalability of XenApp and XenDesktop simplifies the rapid provisioning, patching, and updated of 1,000 of apps and desktops to 100,000 of users anywhere at any time, making it easier for IT to meet the demands of a growing workforce within a limited budget.</p>	✓	✓	✓	✓	✓	✓
<p>Open architecture permits virtual apps and desktops to be deployed on any hypervisor include Citrix XenServer, Microsoft Hyper-V, and VMware vSphere, cloud management platform, or storage infrastructure to give IT the freedom and flexibility needed to control costs, without impacting the user experience or performance.</p>	✓	✓	✓	✓	✓	✓
<p>Microsoft Hyper-V integration offers easy integration with your existing Hyper-V virtualization solution and the flexibility to expand or change your infrastructure at any time.</p>	✓	✓	✓	✓	✓	✓
<p>XenServer Hypervisor (included) is included for free with XenApp and XenDesktop media kit creating a highly scalable, manageable and agile virtualization infrastructure.</p>	✓	✓	✓	✓	✓	✓
<p>VMware vSphere integration offers easy integration with your existing vSphere virtualization solution and the flexibility to expand or change your infrastructure at any time.</p>	✓	✓	✓	✓	✓	✓
<p>Microsoft System Center integration makes it easy to manage pooled desktop and server images from System Center while leveraging policy enforcement and report processes and tools provided in SCCM.</p>		✓	✓	✓	✓	✓

XenApp/XenDesktop 7.6 Feature Matrix

<p>NetScaler load-balancing (optional) actively monitors services and web traffic to intelligently load balance users across XenApp and XenDesktop infrastructure to assure optimal uptime and consistency user access even during planned, unplanned, or scheduled maintenance window.</p>	✓	✓	✓	✓	✓	✓
<p>Integration with NetScaler HDX Insight™ provides end-to-end user experience visibility across the network to provide in-depth visibility into the performance of the ICA protocol ensuring administrators have all the information for troubleshooting and improving user experience with XenApp and XenDesktop infrastructure.</p>			✓			✓



WORK BETTER. LIVE BETTER.